



**What if everyone's  
dream shower can be  
brought to life ...**

Economical, reliable and accessible  
**wedi Fundo shower systems**

... **wedi**<sup>®</sup>

# What if there is a perfect solution for everyone ...

## Fundo benefits at a glance

The **wedi Fundo shower systems** offer innovative solutions for walk-in showers in a variety of designs and functions. Whether new construction or bathroom refurbishment – they meet the strictest requirements.



### Accessible

Low construction height, ideal for renovation and refurbishment



### Convenient

Factory-integrated precise gradient



### Robust

Extremely stable surface, wheelchair accessible



### Adaptable

Can be cut to size without loss of warranty



### Diverse

Large selection of designs and functions



### Lightweight

Advantages in transport, storage and installation



### Clean

Less dirt and moisture ingress compared to conventional construction methods

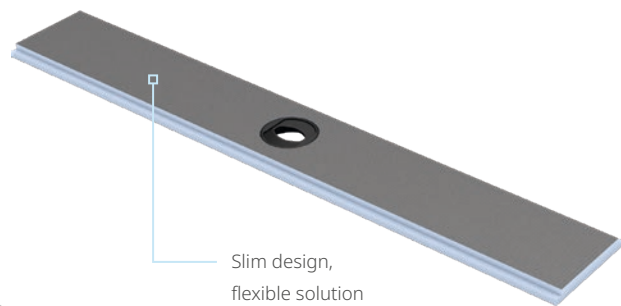
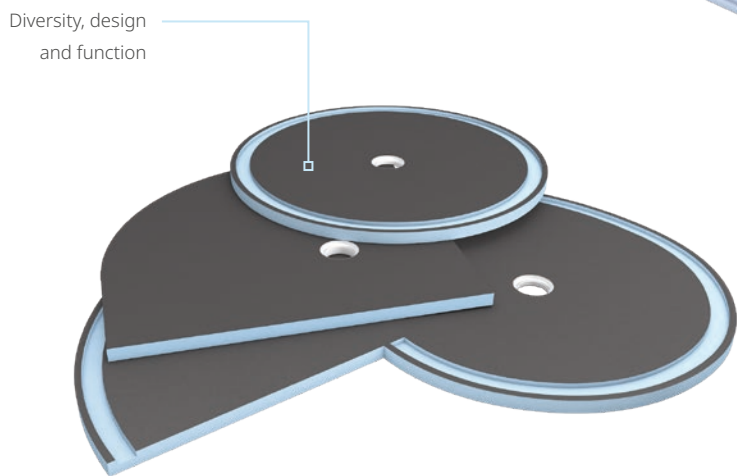
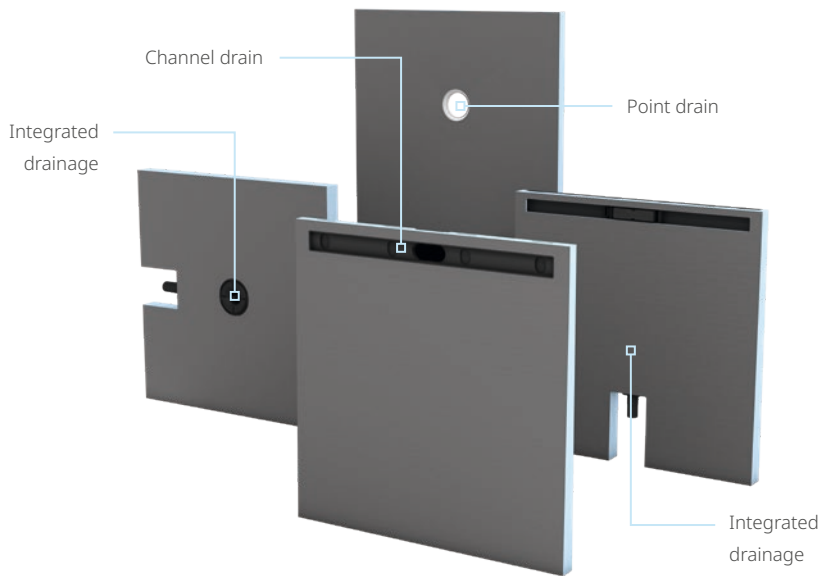

Scan now and see all products at a glance!



**What if any  
installation situation  
is easy to master ...**





...wedi®

# What if precision can be flexible ...

## Fundo Flex: slim design, flexible solution

The requirements on bathroom construction sites vary, but one thing remains the same: customers would like a long-lasting, aesthetic solution. This is where the Fundo Flex comes into play. If you are looking for a slim, versatile and easy-to-install solution, this channel element with a particularly narrow channel profile is the perfect choice. With a **width** of just **35 mm**, it fits perfectly into any bathroom design and thanks to its unique ability to **move, rotate and precisely align with the wall**, offers maximum installation flexibility.



**Fundo Flex**  
Customisable channel element

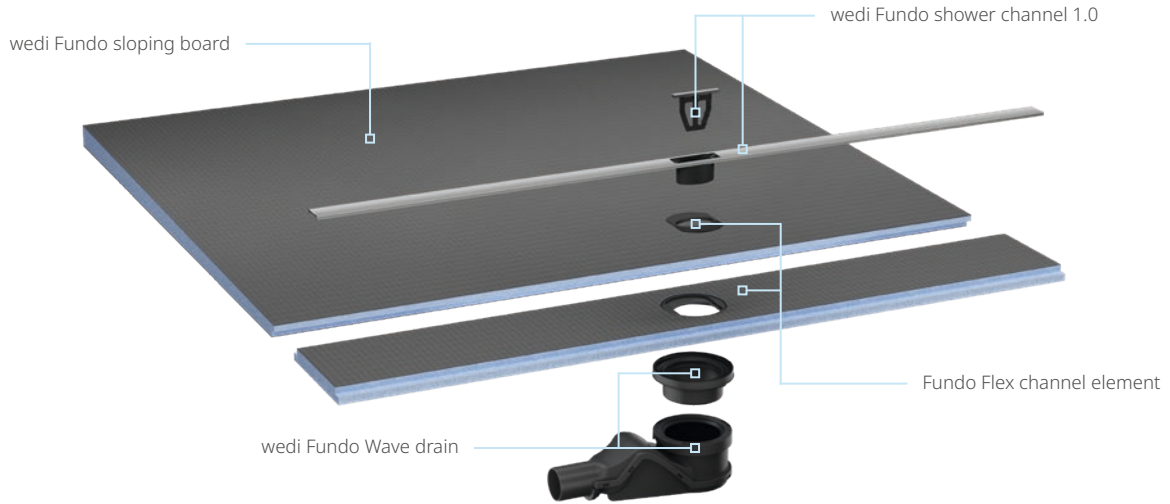

### Just perfect

- Adaptable linear drainage with only 35 mm wide channel profile
- Suitable for any shower area and ideal even for narrow enclosures
- Maximum flexibility thanks to the channel profile that can be moved, rotated and precisely aligned
- Easy installation thanks to the adjustable sloping boards with factory-integrated gradient

### Precisely flexible



Close-to-wall installation



Offset installation



Centred installation



Narrow, 35 mm wide channel

# What if there is a suitable solution for every requirement ...

## Classic systems

Perfectly combined: with classic Fundo shower systems, there is an **appropriate drainage for every installation situation**. A large selection of designer covers is available for both point and linear drains. For optimally watertight connections to adjacent surfaces, the wedi Fundo sealing set, consisting of wedi 520, wedi Tools sealing tape and wedi Tools sealing corners, is the ideal solution.

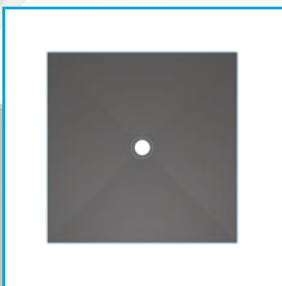

**Fundo Primo**  
Point drainage, square

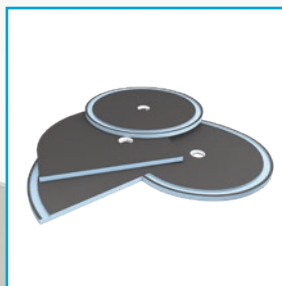

**Fundo Borgo, Fundo Trollo,  
Fundo Nautilo**  
Point drainage, round



**Fundo Riolito Neo,  
Fundo Riolito**  
Linear drainage, offset

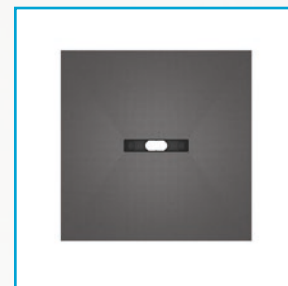

**Fundo Riofino**  
Linear drainage, centred

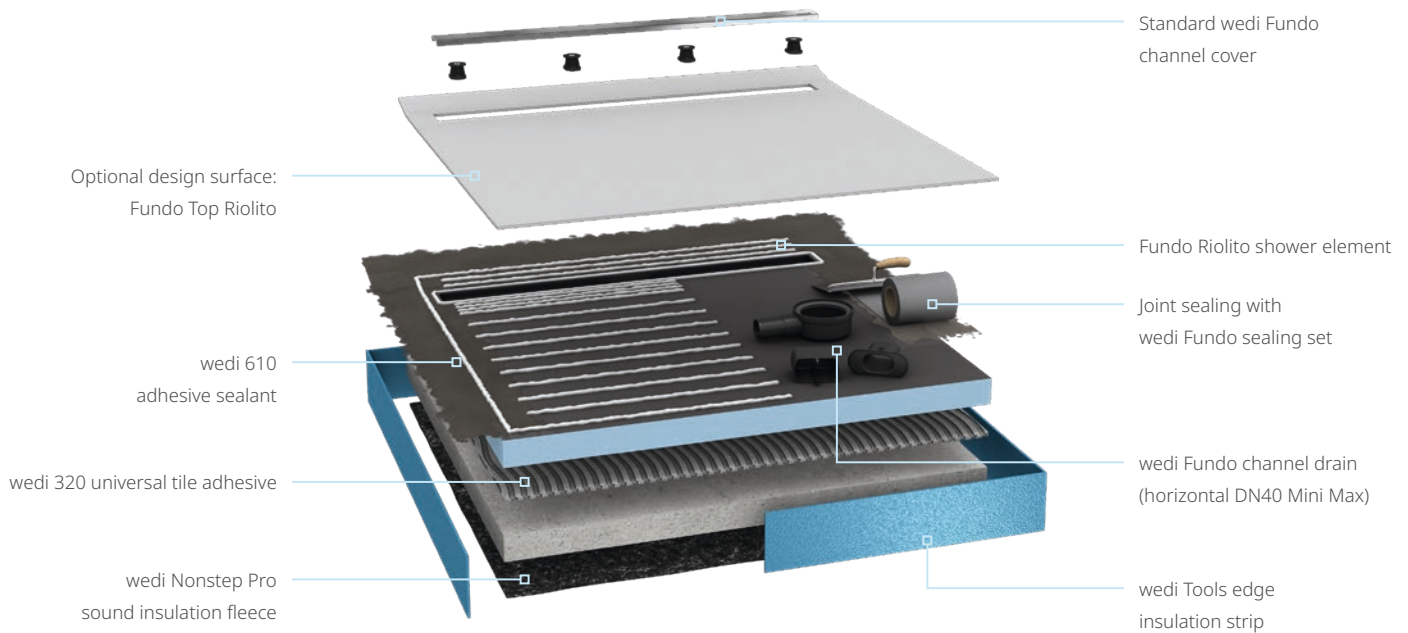

## Just perfect

- Vertical or horizontal drainage, suitable for any installation situation
- Proven system of precisely matched individual components
- Individual design variants for point drainage (round and angular formats)
- Installation variants (close to the wall, at a distance from the wall, centred) for linear drainage

## How it works

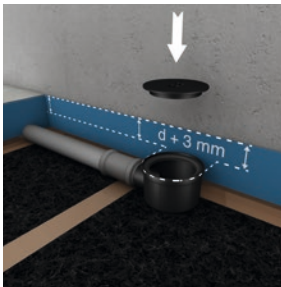

Position the drain bowl.

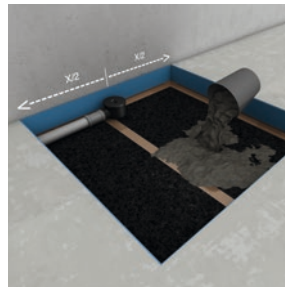

Fill in the shower area.

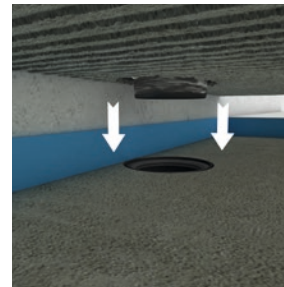

Apply **wedi 320** tile adhesive to the underside of the **wedi Fundo** shower element and bond it to the floor.



Seal the joints between the **wedi Fundo** shower element and adjacent surfaces with the **wedi Fundo** sealing set.

# What if replacing the bathtub with a shower is simple ...

## Complete systems with integrated drain technology

Convenient and reliable: **for all complete Fundo shower systems, the drainage is already integrated into the shower element during the manufacturing process.** Available in a wide range of sizes, with pipe-outlet areas on the long or short side, there is a suitable design for almost every requirement. The sealing of the joints between complete Fundo shower systems and adjacent surfaces is also very easy. The wedi Fundo sealing set includes everything you need: wedi 520, wedi Tools sealing tape and wedi Tools sealing corners.

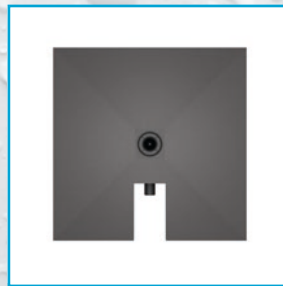

**Fundo Integro**  
Connection line: DN50,  
just 90 mm total height and  
standard-compliant

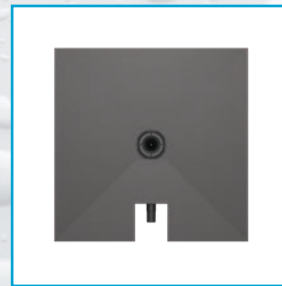

**Fundo Plano**  
Connection line: DN40,  
just 65 mm total height



**Fundo Plano Linea**  
Connection line: DN40,  
70 mm total height

Fundo Integro  
compliant  
**DIN EN  
1253**



wedi Fundo drain grid 6.1

Optional design surface:  
Fundo Top Integro

wedi 610  
adhesive sealant

Joint sealing with  
wedi Fundo sealing set

Fundo Integro  
shower element

wedi Tools edge  
insulation strip

wedi Tools sealing corners  
800 x 800 mm

wedi 320 universal tile adhesive  
wedi Nonstep ProS  
sound insulation fleece

## Just perfect

- Simple, fast and safe installation thanks to the factory-integrated drain technology
- Complete package with shower element, drain technology, drain grid and sealing sheet

## How it works

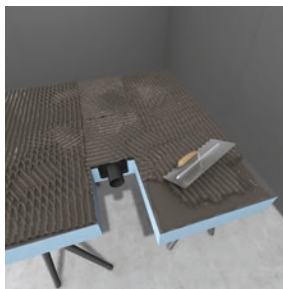

Apply **wedi 320** tile adhesive to the underside of the **wedi Fundo**.

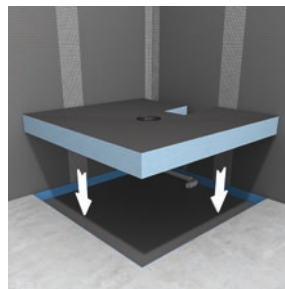

Bond the **wedi Fundo** to the floor and connect the drain.

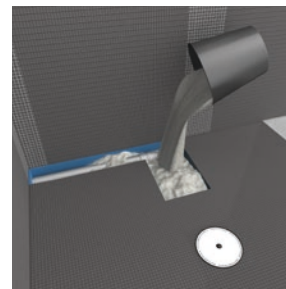

Fill in the pipe-outlet area and seal it with the supplied **sealing sheet**.

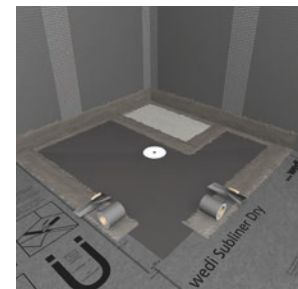

Seal the joints between the **wedi Fundo** and adjacent surfaces with the **wedi Fundo sealing set**.

# What if the subsurface is wood ...

## Special solutions for suspended timber floors

Of course, reliable and secure: with wedi, you can **easily install floor-level showers, even in/on moisture-sensitive wooden surfaces**. Our special solutions with optimally matched components ensure maximum reliability.

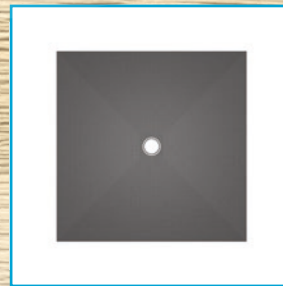

**Fundo Ligno Plus**  
23 mm outer edge



**Fundo RioLigno**  
25 mm outer edge

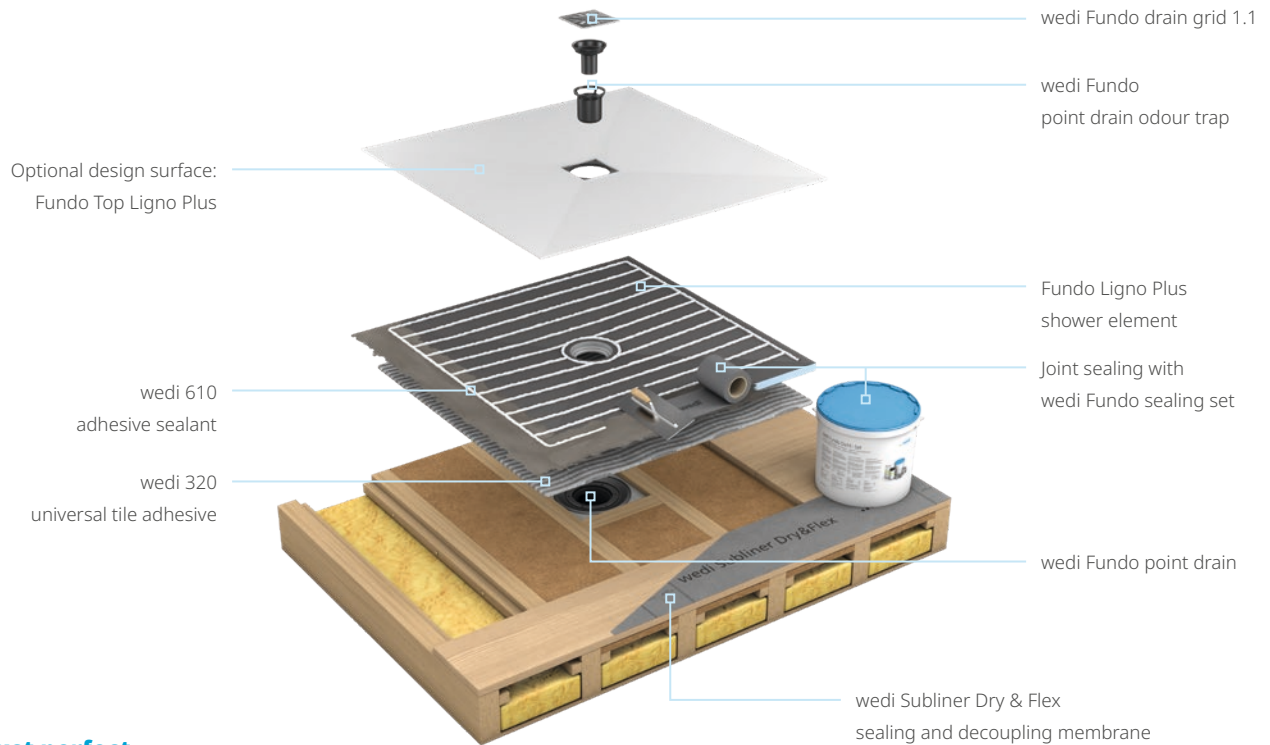

## Just perfect

- Special shower elements for flush-to-floor installations in suspended timber floors
- Fast and safe installation thanks to factory-integrated precise gradients
- Optimal base for tiles or Fundo Top design surfaces

## How it works

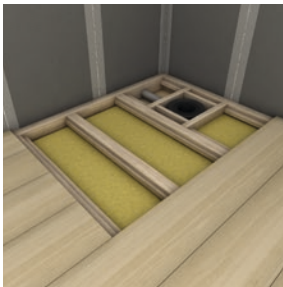

Position, align and stabilise the **wedi Fundo drain** in the suspended timber floor.

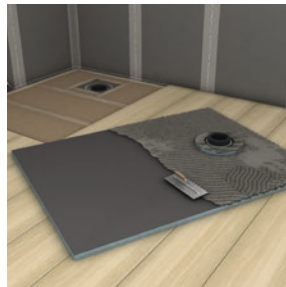

Bond the **wedi Fundo** to the floor with **wedi 320 tile adhesive**.

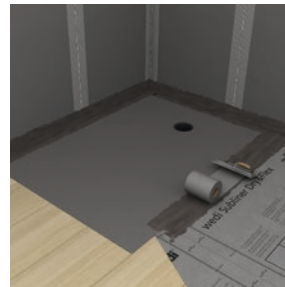

Seal the joints between the shower element and adjacent surfaces with the **wedi Fundo sealing set**.

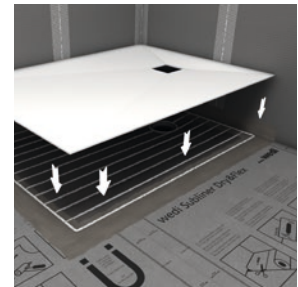

Bond the matching **wedi Fundo Top design surface** to the wedi Fundo with **wedi 610 adhesive and sealant**.

# What if the installation is even easier ...

## **wedi Fundo drain substructure element**

Available for both point and linear drainage, our substructure elements aid precise alignment and adequate support of the drain and thus ensure a fast and secure installation. This eliminates the otherwise complex creation of formwork and subsequent filling with mortar.

## **wedi Fundo point or channel drain**

Special, dry-fit drain technology for point and linear drainage is available in vertical and horizontal variants with different connections and construction heights. Vertical channel drains with fire protection collar are also available for improved fire protection.

## **wedi Fundo substructure set**

Allowing for construction heights of 30, 60 and 90 mm it brings flush-to-floor showers to the desired height. Each set consists of two substructure elements with heights of 30 and 60 mm and three pre-formed drain mount rings to suit Fundo point and channel drains. Exterior dimensions, drain and pipe position can be individually adjusted on site.

## **wedi Fundo drain grids**

Whether round or square, in standard or in solid stainless steel design – wedi Fundo drain grids are the ideal solution for tiles in all formats and colours. Of course, they always supplied with matching plastic or stainless steel frames. Optical highlight: the wedi Fundo drain grid 7.1 with blackened channel.

## **wedi Fundo channel cover**

Available in standard, exclusive and tileable variants, our channel covers transform any walk-in shower into an elegant design highlight.

## **wedi Fundo drain covers with PVD coating**

Designed to match the colours of common fittings from leading manufacturers in "metallic black", "metallic rose-gold" and "metallic gold", our metallic covers are available for point and linear drainage. The high-quality brushed PVD surface ensures consistent colour brilliance.

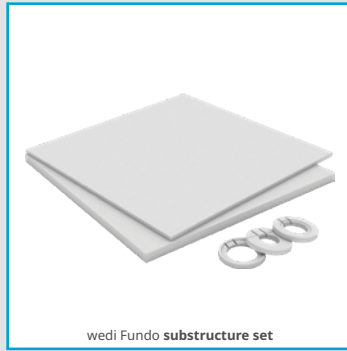
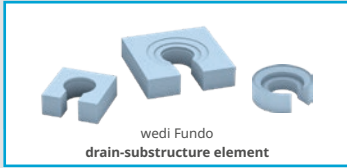

# wedi Fundo accessories

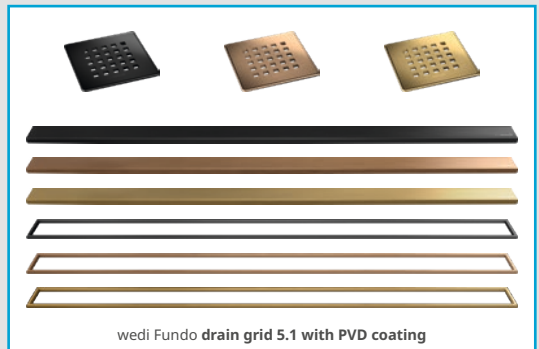
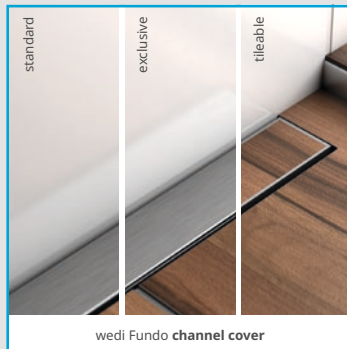

# What if the surface and the substructure harmonise perfectly ...

## Fundo Top

The range offers perfectly matched design surfaces for wedi Fundo shower systems. Ready-to-install, large format and seamless, they are available in a variety of attractive design options. With three modern optics - **natural stone**, **marble and monochrome** - the wedi Top Line opens up unlimited design possibilities.



### Matching

Perfectly matched to the slopes of wedi Fundo shower elements



### Diverse

Large selection of colours and textures for a variety of design options



### Hygienic

Antibacterial and low-maintenance surfaces



### Sturdy

Non-slip in wet areas



### Modern

Seamless, aesthetic design for a modern look



### Smart

Low weight, installs on almost all surfaces



### Robust

Shock-resistant and flexible, waterproof and UV-resistant



### Clean

Installation without dirt and noise



Non-slip in wet areas

**Just perfect**

- Modern, large format and seamless design
- Low-maintenance, joint-free surfaces
- Hygienic, antibacterial finish
- Simple, secure and fast installation

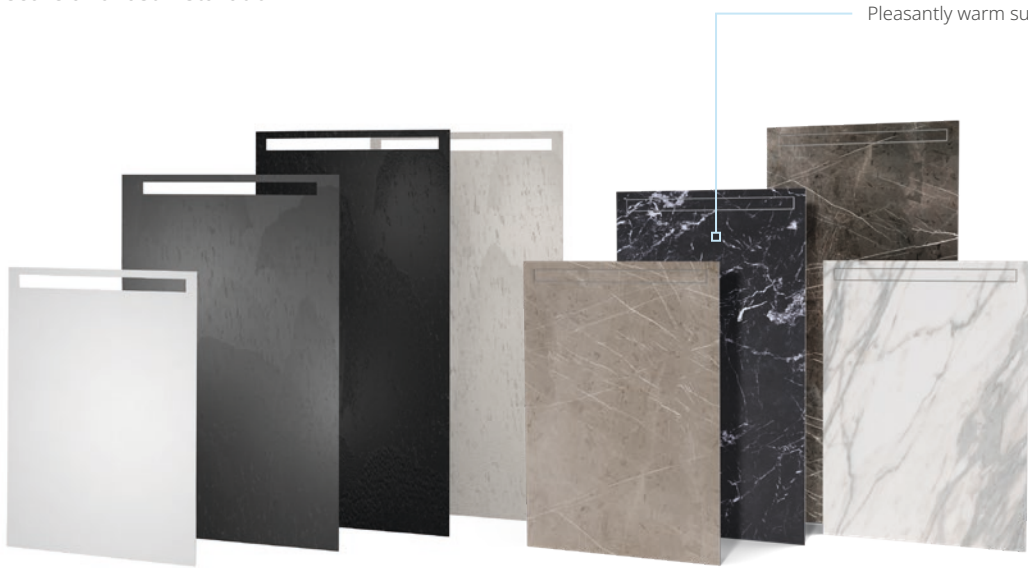

Pleasantly warm surfaces

# What if you can plan your desired shower easily online ...

## wedi Shower Configurator

Any flush-to-floor shower can be planned quickly and easily using the wedi Shower Configurator. It does not only guide you through the many options step-by-step, but also recommends wedi products suitable for the individual installation situation set by you.

Try it now at [www.wedi.net/en/shower-configurator](http://www.wedi.net/en/shower-configurator)



# What if small steps achieve a big impact ...

## Shaping the future step-by-step

15 years ago, wedi took the first step towards sustainability and has been committed to a sustainable future ever since. With the wedi GREEN STEPS we show concrete measures and measurable progress demonstrating how small, consistent steps can bring about long-term change. The approach goes beyond environmental protection and covers issues such as health, equality and the protection of land and water habitats.

**Find out more at [www.wedi.net/en/wedi/engagement-and-sustainability/green-steps](http://www.wedi.net/en/wedi/engagement-and-sustainability/green-steps)**



**GREEN STEPS**



Hollefeldstraße 51  
48282 Emsdetten  
Germany

Phone + 49 25 72 156-0

info@wedi.de  
www.wedi.net

... **wedi**®